

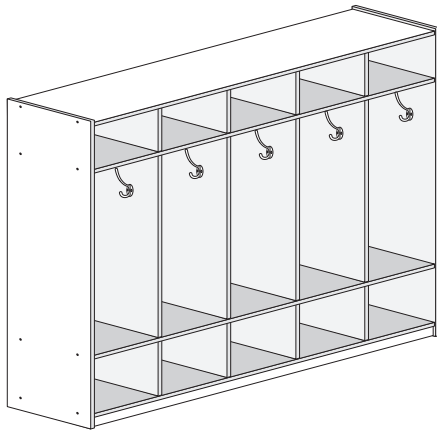

Mt. Laurel, NJ 08054 USA  
www.ecr4kids.com

**5 Section Coat Locker**  
Model# ELR-0425



**⚠ WARNING:**

**Adult Assembly Required.**

- Two adults recommended.
- Contains small parts, sharp points and edges.
- Do not stand, sit, kneel, climb, lean or pull on unit for support.
- Never leave children unattended.
- Do not place unit near high heat or moisture.
- Adult supervision recommended.

**TOOLS INCLUDED**

- Hex Tool (1)









**TOOLS NEEDED**

- Phillips Screwdriver

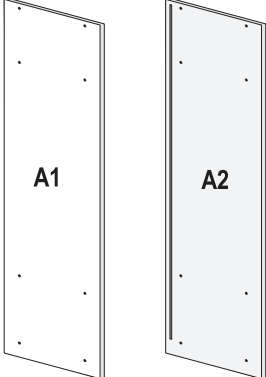
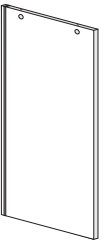
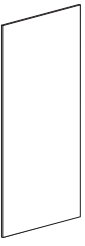
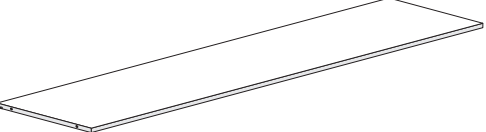
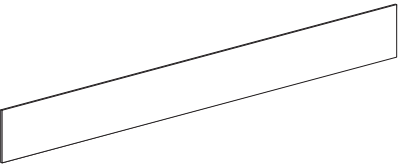
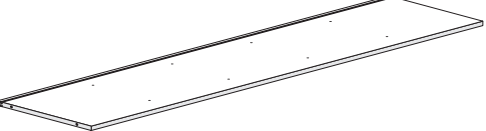
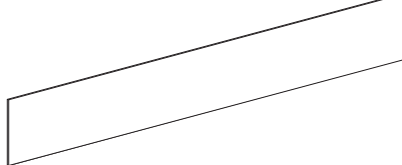
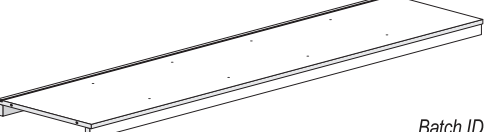
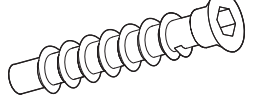

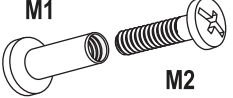
**Parts List**

BEFORE ASSEMBLING, MAKE SURE YOU HAVE ALL THE PARTS

<p><b>A</b> Left &amp; Right Side Panels (1/1)</p> 	<p><b>G</b> Middle Dividers (4)</p> 	<p><b>H</b> Middle Back Panels (5)</p> 
<p><b>B</b> Top Panel (1)</p> 	<p><b>I</b> Upper Back Panel (1)</p> 	
<p><b>C</b> Upper/Lower Shelves (2)</p> 	<p><b>J</b> Lower Back Panel (1)</p> 	
<p><b>D</b> Bottom Shelf (1)</p>  <p><i>Batch ID Sticker located on underside</i></p>	<p><b>K</b> Hex Screws (40)</p>  <p><i>Use the Hex Tool</i></p>	
<p><b>E</b> Upper Dividers (4)</p> 	<p><b>M</b> Hanger Hook Posts &amp; Screws (12/12)</p>  <p><i>Use a Phillips Screwdriver</i></p>	<p><b>N</b> Hanger Hooks (10)</p> 
<p><b>F</b> Lower Dividers (4)</p> 	<p><b>L</b> Cam Posts &amp; Cam Locks (24/24)</p>  <p><i>Use a Phillips Screwdriver</i></p>	

## 1 Install Upper Dividers onto Upper Shelf

Install the four **Upper Dividers (E)** to the **Upper Shelf (C)** with eight **Hex Screws (K)** using the Hex Tool.

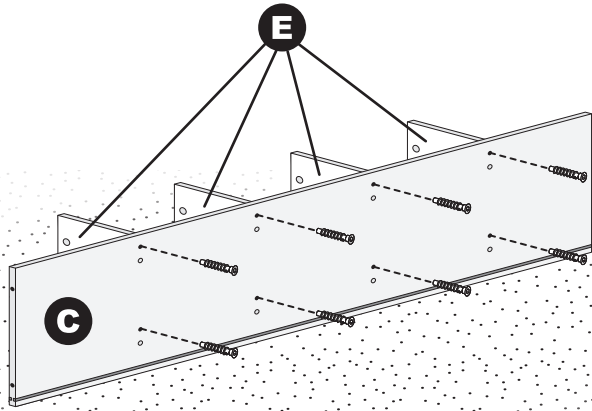

## 2 Connect Top Panel to Upper Dividers

Install eight **Cam Posts (L1)** into the threaded plastic inserts on the underside of **Top Panel (B)** and **Upper Shelf (C)** with a Phillips screwdriver.

*Reminder: Do not overtighten, as the plastic threads can be stripped.*

Place two **Cam Locks (L2)** into the recessed holes on each **Upper Divider (E)**, with the arrow facing the closest edge.

Insert the **Top Panel (B)** Cam Posts into the holes on the top edge of the **Upper Dividers (E)**. Turn the Cam Locks clockwise with a Phillips screwdriver to lock the **Upper Dividers (E)** onto the posts.

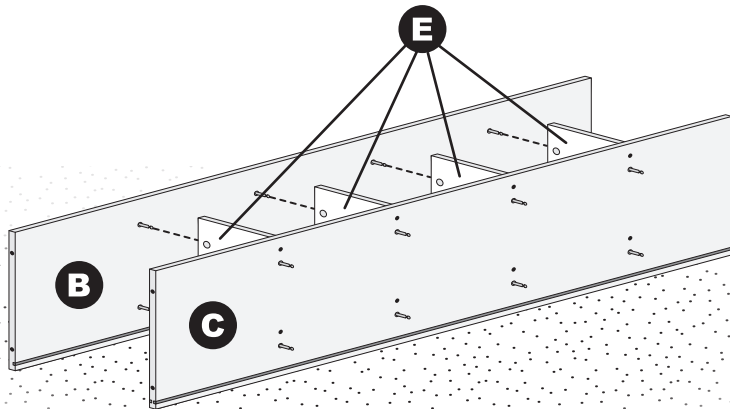

## 3 Install Middle Dividers onto Lower Shelf

Install the four **Middle Dividers (G)** to the **Lower Shelf (C)** with eight **Hex Screws (K)** using the Hex Tool.

*Reminder: Make sure the grooves on the **Middle Dividers (G)** align together with those on the **Lower Shelf (C)**.*

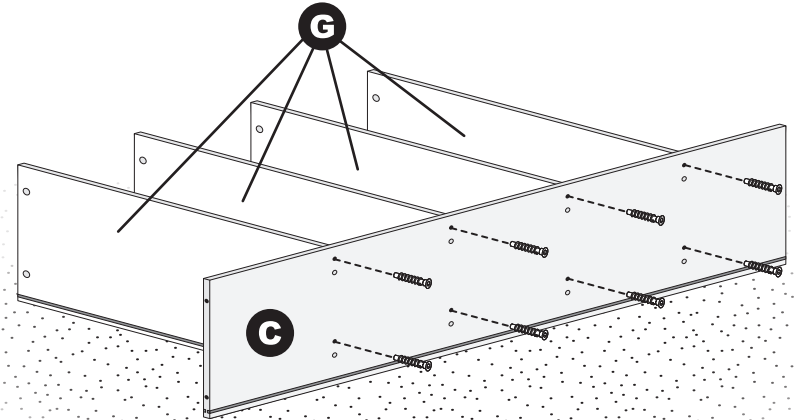

## 4 Install Lower Dividers onto Bottom Shelf

Install the four **Lower Dividers (F)** to the **Bottom Shelf (D)** with eight **Hex Screws (K)** using the Hex Tool.

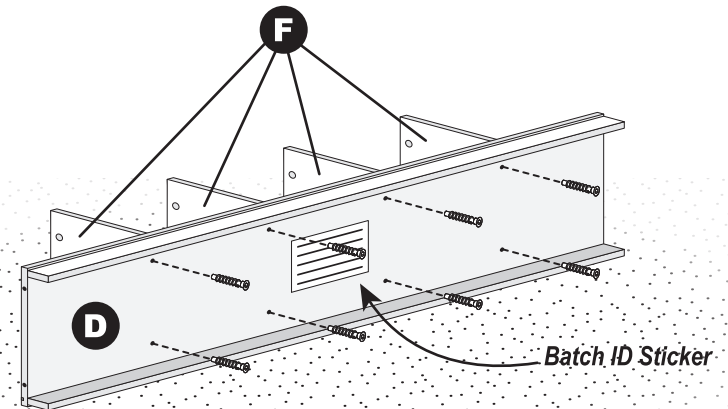

See Next Page

## 5 Connect Lower Shelf to Lower Dividers

Install eight **Cam Posts (L1)** into the threaded plastic inserts on the underside of **Lower Shelf (C)** with a Phillips screwdriver. **Reminder:** Do not overtighten, as the plastic threads can be stripped.

Place two **Cam Locks (L2)** into the recessed holes on each **Lower Divider (F)**, with the arrow facing the closest edge.

Attach the **Lower Dividers (F)** onto the Cam Posts on the underside of the **Lower Shelf (C)**, turn the Cam Locks clockwise with a Phillips screwdriver to lock the **Lower Dividers (F)** onto the posts.

**Two Adults Recommended:**  
Carefully rotate the unit upright.

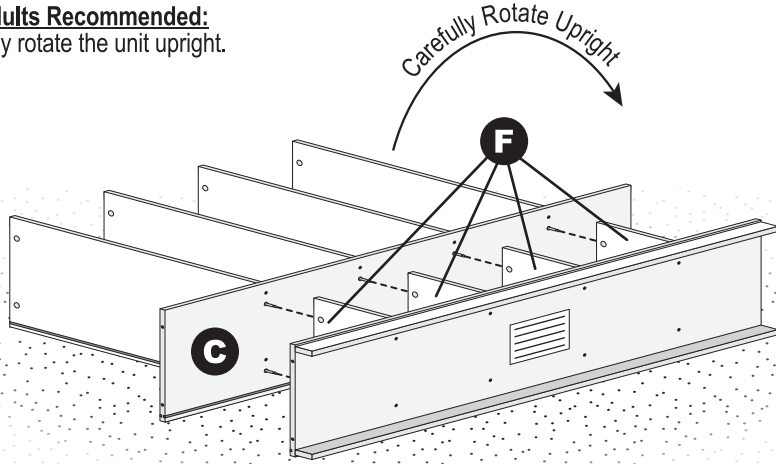

## 6 Slide Middle Back Panels into Place

Slide three **Middle Back Panels (H)** into the grooves on the **Middle Dividers (G)** as shown, until fully seated into the groove on the topside of the **Lower Shelf (C)**.

**Tip:** If the Middle Back Panels do not slide in easily, wiggle the panels while pushing into place.

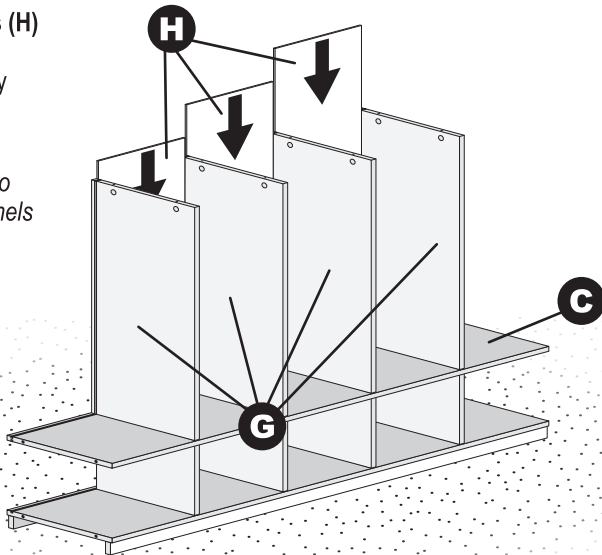

## 7 Connect Upper Shelf to Middle Dividers

Place two **Cam Locks (L2)** into the recessed holes on each **Middle Dividers (G)**, with the arrow facing the closest edge.

**Two Adults Recommended:**  
Insert the **Upper Shelf (C)** Cam Posts into the holes on the top edge of the **Middle Dividers (G)**.

Turn the Cam Locks clockwise with a Phillips screwdriver to lock the **Middle Dividers (G)** onto the posts.

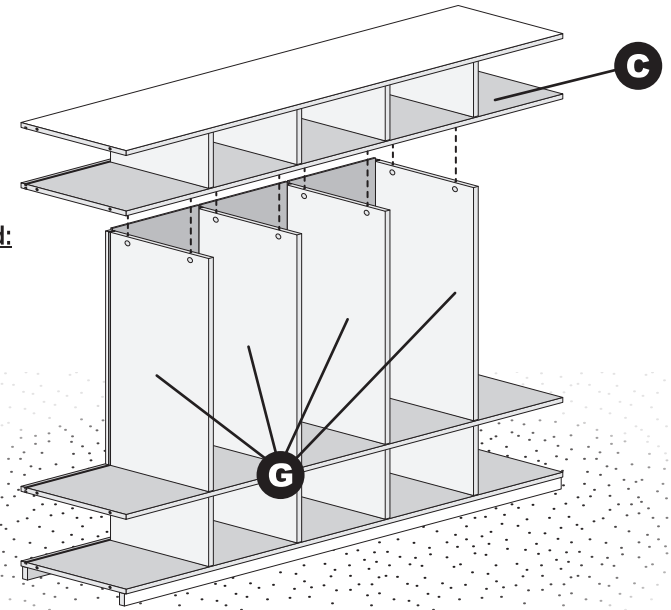

## 8 Insert the remaining Middle Back Panels

Slide the remaining two **Middle Back Panels (H)** into the grooves on the **Lower/Upper Shelves (C)** as shown, until fully seated into the groove on the side of the **Middle Dividers (G)**.

**Tip:** If the Middle Back Panels do not slide in easily, wiggle the panels while pushing into place.

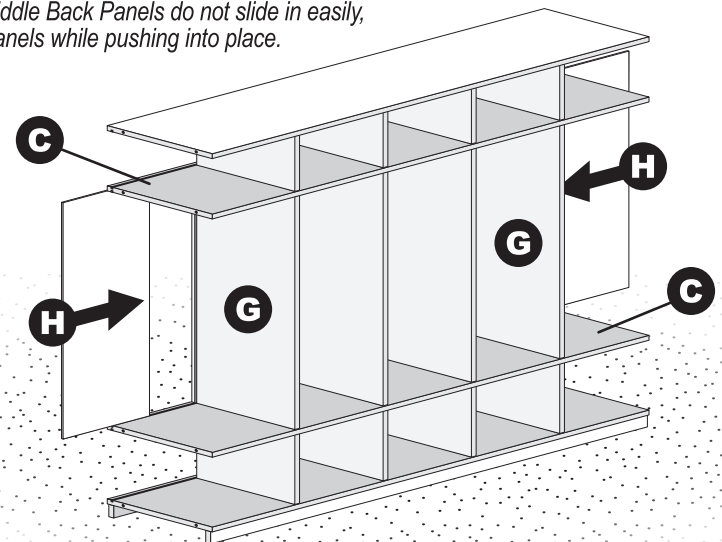

See Next Page

## 9 Install the Left Side Panel

Install the **Left Side Panel (A1)** to the **Top Panel (B)**, **Lower/Upper Shelves (C)** and **Bottom Shelf (D)** with eight **Hex Screws (K)** using the Hex Tool.

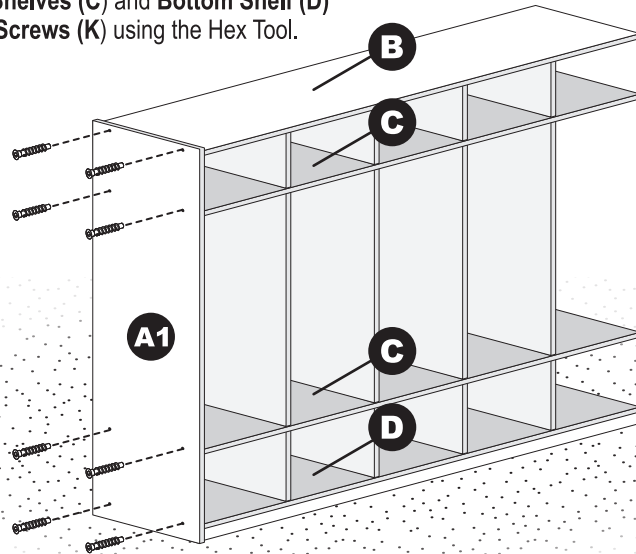

## 11 Install the Right Side Panel

Install the **Right Side Panel (A2)** to the **Top Panel (B)**, **Lower/Upper Shelves (C)** and **Bottom Shelf (D)** with eight **Hex Screws (K)** using the Hex Tool.

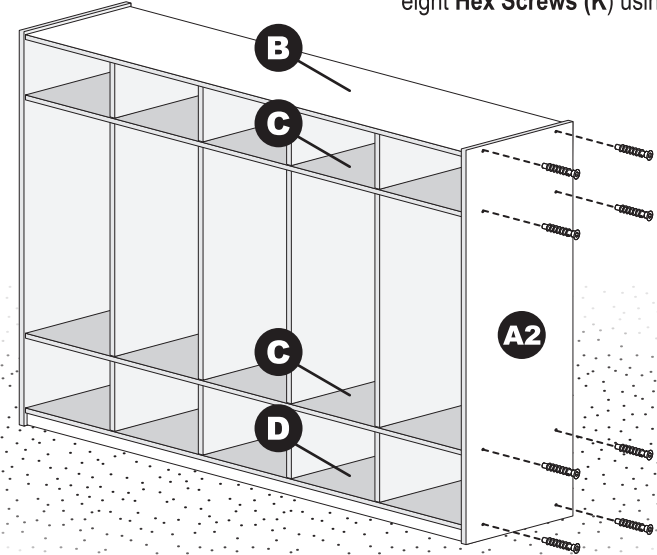

## 10 Slide Upper/Lower Back Panels into Place

Slide the **Upper/Lower Back Panels (I/J)** into the grooves on the **Top Panel (B)**, **Lower/Upper Shelves (C)** and **Bottom Shelf (D)** as shown, until fully seated into the groove on the inside of the **Left Side Panel (A1)**.

*Tip: If the Upper/Lower Back Panels do not slide in easily, wiggle the panels while pushing into place.*

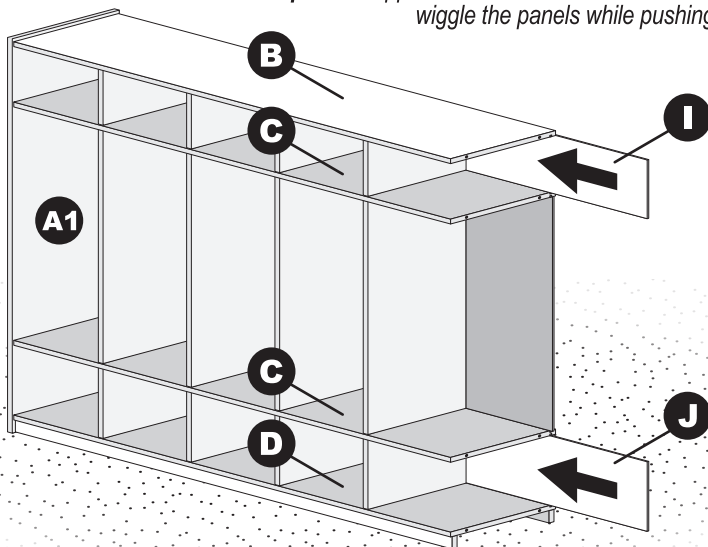

## 12 Install the Hanger Hooks to the Dividers

Install two **Hanger Hooks (N)** to each locker section by threading the **Hanger Hook Posts & Screws (M1/M2)** together from both sides of each vertical divider.

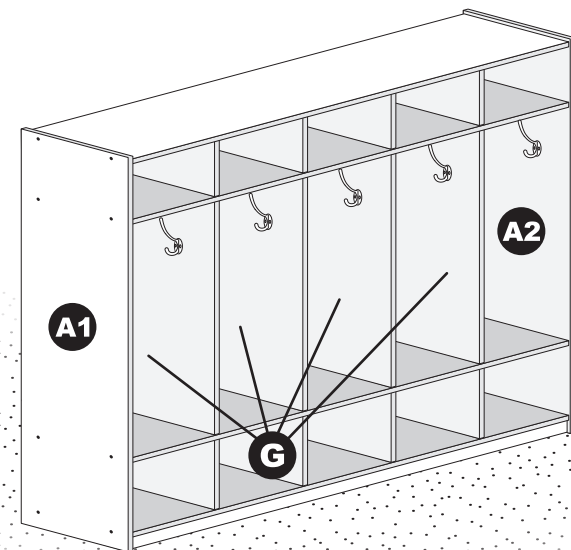

See Next Page



We appreciate your purchase of the 5 Section Coat Locker. ECR4KIDS® has made every effort to supply a quality product that with proper use and care, will provide many years of trouble-free use.

If you experience any difficulties with this product, please email us at [ecrcs@ecr4kids.com](mailto:ecrcs@ecr4kids.com) or call toll-free at (855) ECR-4KIDS (Monday - Friday, 7:00am - 4:00pm Pacific Standard Time)

**Please do not return** to place of purchase as ECR4KIDS® will replace defective part(s) and/or product.



ECR4KIDS® guarantees the quality of all our products. You can trust the quality and safety of our furniture and materials, along with the peace of mind that our products are made to last. If for any reason you are not satisfied with the quality or workmanship of our products, we will replace the item or refund the sale.

#### Care and Cleaning

Clean wood with a damp cloth or sponge using warm water and mild soap. Wipe dry.

Do not place near heat, moisture or vaporizer which may cause wood to warp and peel.

Check for loose or worn parts periodically and tighten or replace as necessary.

**Record the manufacture date here.**  
**Information is located on the Batch ID sticker and on the shipping carton.**  
**Save this sheet in an accessible place.**

**Model Number:** ELR-0425

**Factory Code:**   D  

**Manufacture Date:** \_\_\_\_\_

**Batch ID Number:** \_\_\_\_\_  
(Located on Part D)