

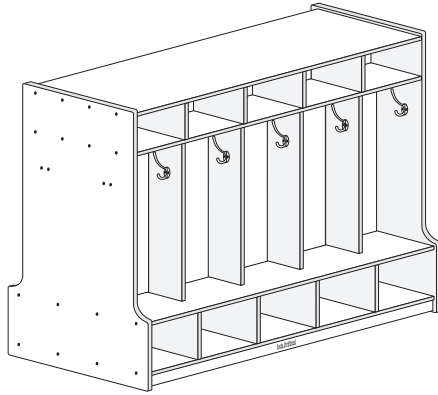

Mt. Laurel, NJ 08054 USA
www.ecr4kids.com

**10 Section
Double-Sided Locker with Bench**
Model#: ELR-0662



⚠ WARNING:

Adult Assembly Required.

Two adults recommended.

- Contains small parts, sharp points and edges.
- Do not stand, sit, kneel, climb, lean or pull on unit for support.
- Never leave children unattended.
- Do not place unit near high heat or moisture.
- Adult supervision recommended.

TOOLS INCLUDED

Hex Tool (1)



TOOLS NEEDED

Phillips Screwdriver



Parts List

BEFORE ASSEMBLING, MAKE SURE YOU HAVE ALL THE PARTS

<p>A Side Panels (2)</p>	<p>F Upper Shelf Dividers (4)</p>	<p>G Upper Shelf Backs (5)</p>
<p>B Top Panel (1)</p>	<p>H Locker Dividers (4)</p>	<p>I Locker Backs (5)</p>
<p>C Upper Shelf Panel (1)</p>	<p>J Lower Shelf Dividers (4)</p>	<p>K Lower Shelf Backs (5)</p>
<p>D Lower Shelf Panel (1)</p>	<p>L Flat Head Hex Screws (16)</p> <p><i>Use the Hex Tool</i></p>	<p>M Decorative Hex Screws (48)</p> <p><i>Use the Hex Tool</i></p>
<p>E Bottom Panel (1)</p> <p><i>Batch ID Sticker located on underside</i></p>	<p>N Cam Posts & Cam Locks (16/16)</p> <p>N1 N2</p> <p><i>Use a Phillips Screwdriver</i></p>	<p>O Hanger Hook Posts & Screws (24/24)</p> <p>O1 O2</p> <p><i>Use a Phillips Screwdriver</i></p>
<p>P Hanger Hooks (20)</p>		

1 Install Locker Dividers to Lower Shelf

Install the four **Locker Dividers (H)** to the **Lower Shelf Panel (D)** with eight **Flat Head Hex Screws (L)** using the Hex Tool.

Install eight **Cam Posts (N1)** into the threaded plastic inserts on the underside of **Lower Shelf Panel (D)** with a Phillips screwdriver.

Reminder: Do not overtighten, as the plastic threads can be stripped.

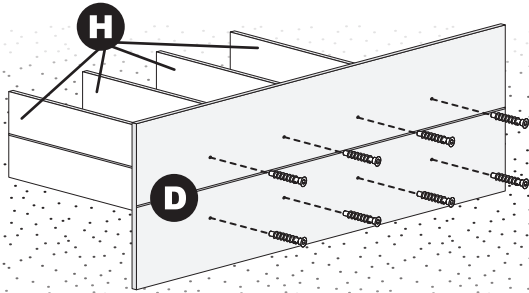

2 Connect Lower Shelf Dividers

Place two **Cam Locks (N2)** into the recessed holes on each **Lower Shelf Dividers (J)**, with the arrow facing the closest edge.

Attach the **Lower Shelf Dividers (J)** onto the Cam Posts on the underside of the **Lower Shelf Panel (D)**, turn the Cam Locks clockwise with a Phillips screwdriver to lock the **Lower Shelf Dividers (J)** onto the posts.

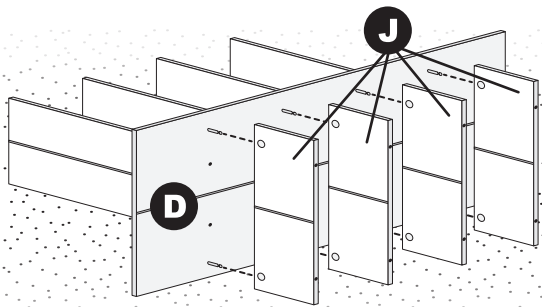

3 Slide the Lower Shelf Backs into Place

Slide three **Lower Shelf Backs (K)** into the grooves on the **Lower Shelf Dividers (J)** as shown, until fully seated into the groove on the underside of the **Lower Shelf Panel (D)**.

Tip: If the Lower Shelf Backs do not slide in easily, wiggle the panels while pushing into place.

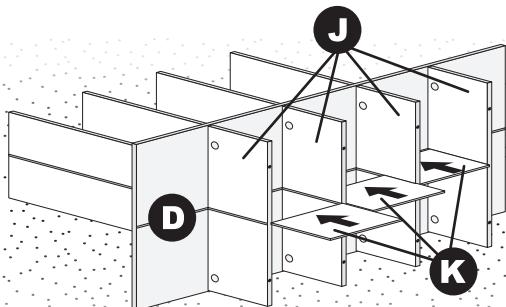

4 Install the Bottom Panel

Install the **Bottom Panel (E)** onto the **Lower Shelf Dividers (J)** with eight **Decorative Hex Screws (M)**, using the Hex tool.

Two Adults Recommended: Carefully rotate the unit upright.

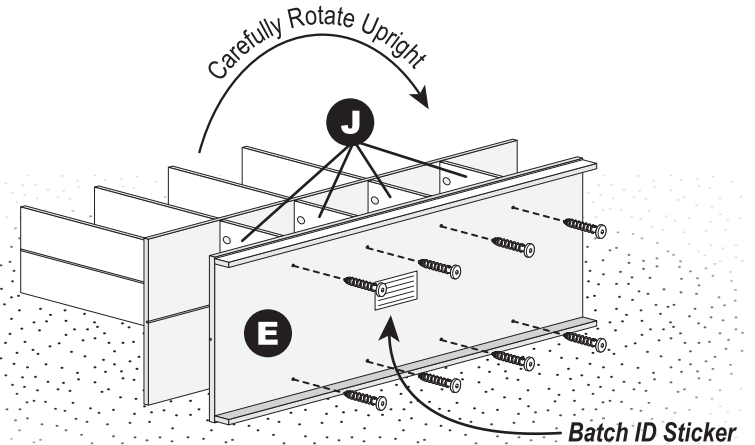

5 Slide the Locker Backs into Place

Slide three **Locker Backs (I)** into the grooves on the **Locker Dividers (H)** as shown, until fully seated into the groove on the top side of the **Lower Shelf Panel (D)**.

Tip: If the Lower Shelf Backs do not slide in easily, wiggle the panels while pushing into place.

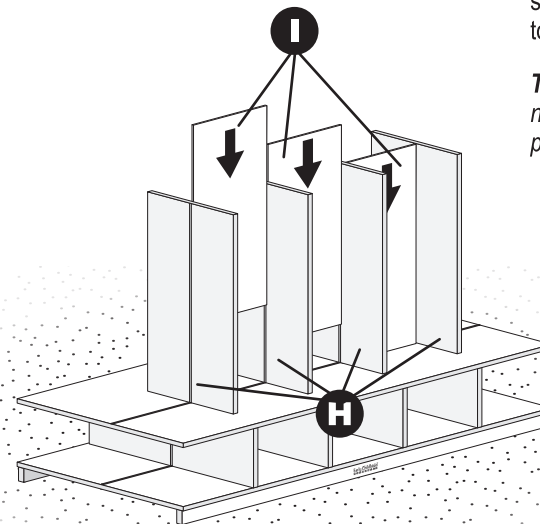

See Next Page

6 Install the Upper Shelf Panel

Install the **Upper Shelf Panel (C)** onto the **Locker Dividers (H)** with eight **Flat Head Hex Screws (L)**, using the Hex tool.

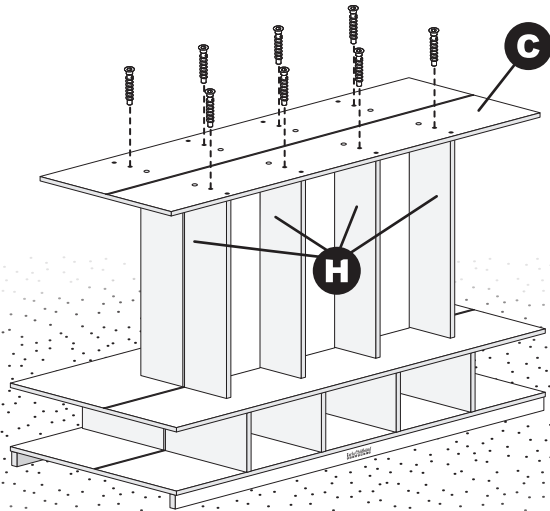

7 Insert the Upper Shelf Dividers

Insert the pre-installed wooden dowels on **Upper Shelf Dividers (F)** into the corresponding holes on the topside of **Upper Shelf Panel (C)**.

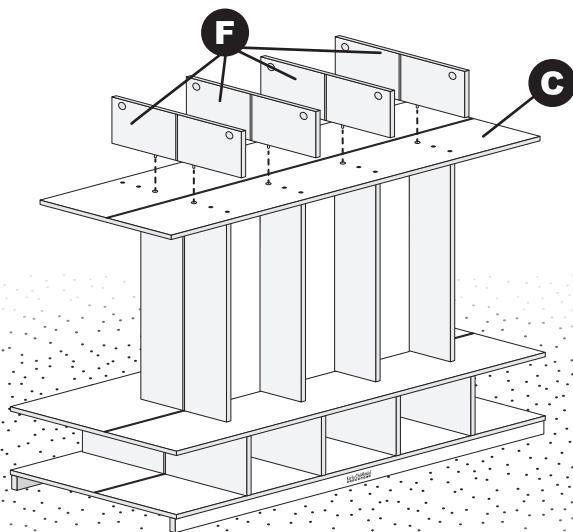

8 Install the Upper Shelf Dividers

Install the **Upper Shelf Dividers (F)** onto the **Upper Shelf Panel (C)** with eight **Decorative Hex Screws (M)** as shown, using the Hex tool.

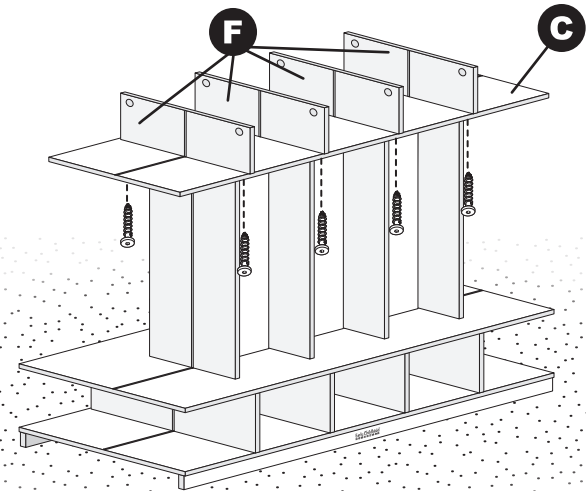

9 Slide the Upper Shelf Backs into Place

Slide three **Upper Shelf Backs (G)** into the grooves on the **Upper Shelf Dividers (F)** as shown, until fully seated into the groove on the topside of the **Upper Shelf Panel (C)**.

Tip: If the Lower Shelf Backs do not slide in easily, wiggle the panels while pushing into place.

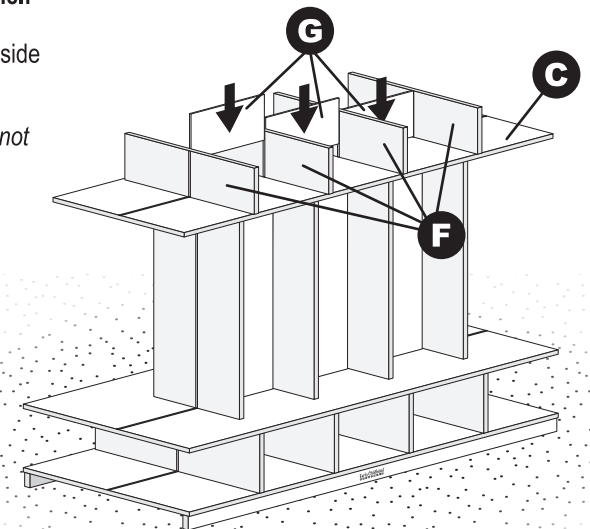

See Next Page

10 Connect the Top Panel

Install eight **Cam Posts (N1)** into the threaded plastic inserts on the underside of **Top Panel (B)** with a Phillips screwdriver.

Reminder: Do not overtighten, as the plastic threads can be stripped.

Place two **Cam Locks (N2)** into the recessed holes on each **Upper Shelf Divider (F)**, with the arrow facing the closest edge.

Insert the Top Panel Cam Posts into the holes on the top edge of the **Upper Shelf Dividers (F)**. Turn the Cam Locks clockwise with a Phillips screwdriver to lock the divider onto the posts.

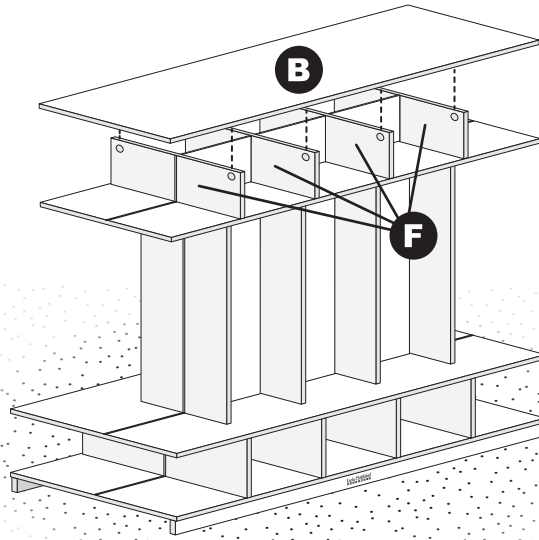

12 Install the Side Panels

Install the **Side Panels (A)** to the assembled unit with sixteen **Decorative Hex Screws (M)** per side, using the Hex Tool.

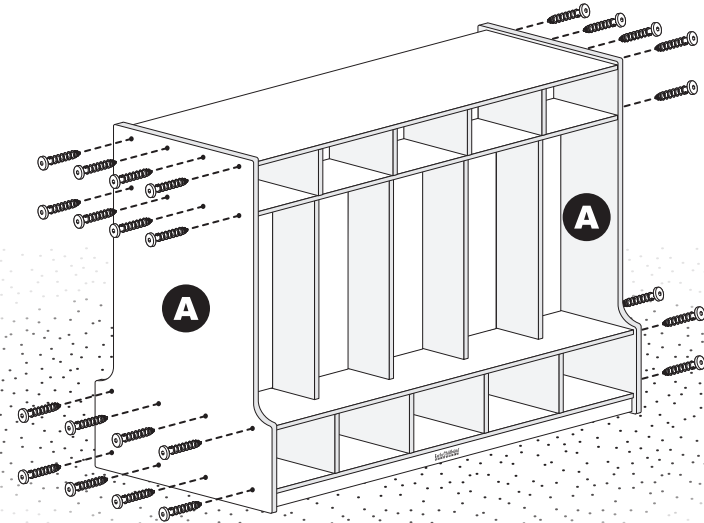

11 Slide the Remaining Backs into Place

Insert the remaining **Upper Shelf Backs (G)**, **Locker Backs (I)** and **Lower Shelf Backs (K)** in the grooves as shown, until fully seated into the groove on the vertical Dividers.

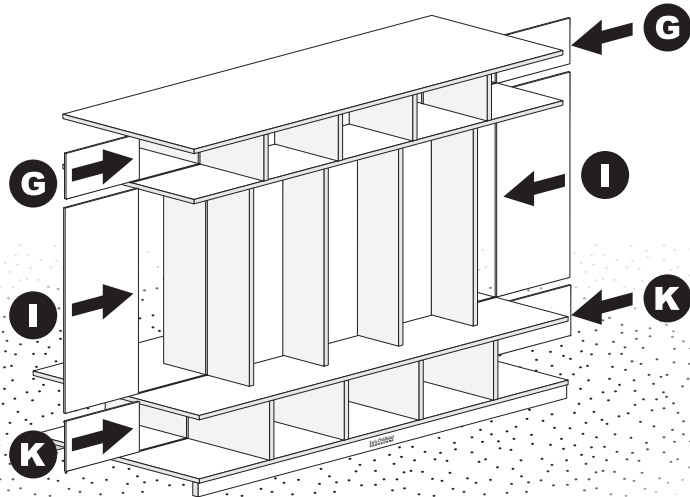

13 Install the Hanger Hooks to the Dividers

Install two **Hanger Hooks (P)** to each locker section by threading the **Hanger Hook Posts and Screws (O1/O2)** together from both sides of each vertical divider.

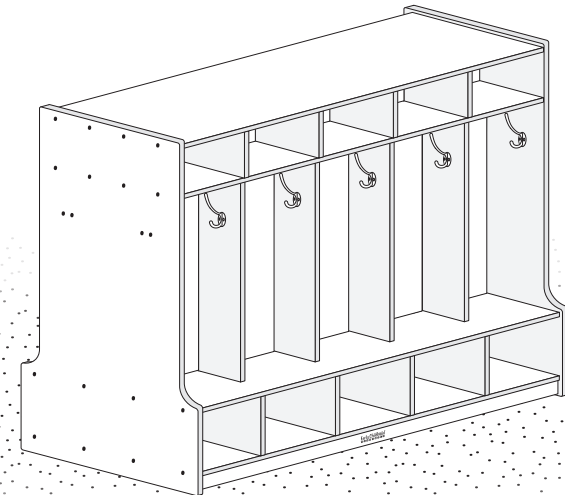

See Next Page



We appreciate your purchase of the 10 Section Double-Sided Locker w/ Bench. ECR4KIDS® has made every effort to supply a quality product that with proper use and care, will provide many years of trouble-free use.

If you experience any difficulties with this product, please email us at ecrcs@ecr4kids.com or call toll-free at (855) ECR-4KIDS (Monday - Friday, 7:00am - 4:00pm Pacific Standard Time)

Please do not return to place of purchase as ECR4KIDS® will replace defective part(s) and/or product.



ECR4KIDS® guarantees the quality of all our products. You can trust the quality and safety of our furniture and materials, along with the peace of mind that our products are made to last. If for any reason you are not satisfied with the quality or workmanship of our products, we will replace the item or refund the sale.

Care and Cleaning

Clean unit with a damp cloth or sponge using warm water and mild soap. Wipe dry.

Do not place near heat, moisture or vaporizer which may cause panels to warp and peel.

Check for loose or worn parts periodically and tighten or replace as necessary.

**Record the manufacture date here.
Information is located on the Batch ID
sticker and on the shipping carton.
Save this sheet in an accessible place.**

Model Number: ELR-0662

Factory Code: D

Manufacture Date: _____

Batch ID Number: _____
(Located on Part E)