

A S202052

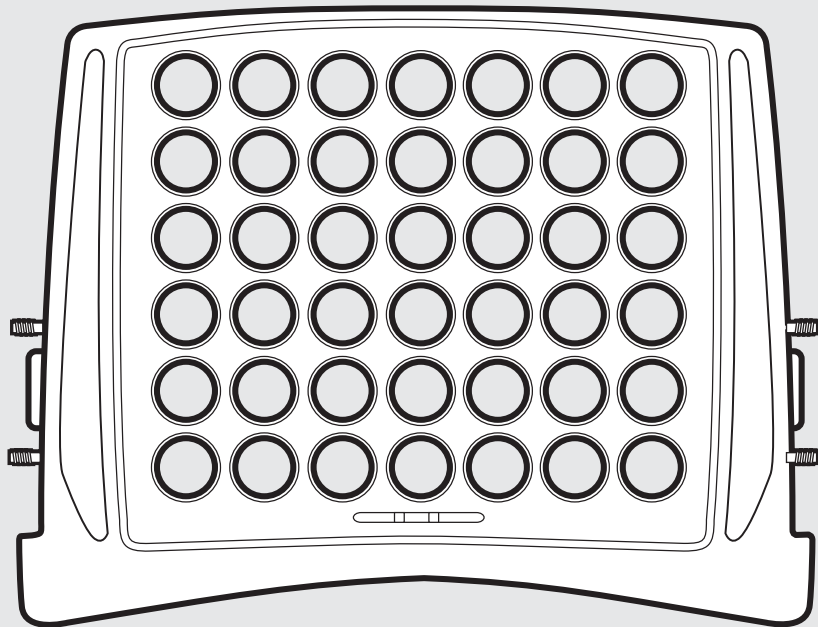

B S004952

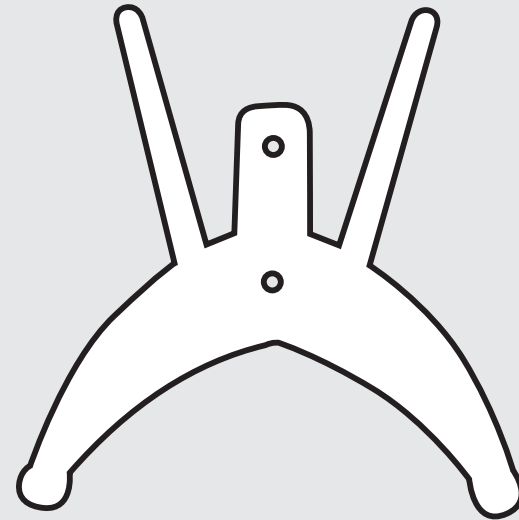
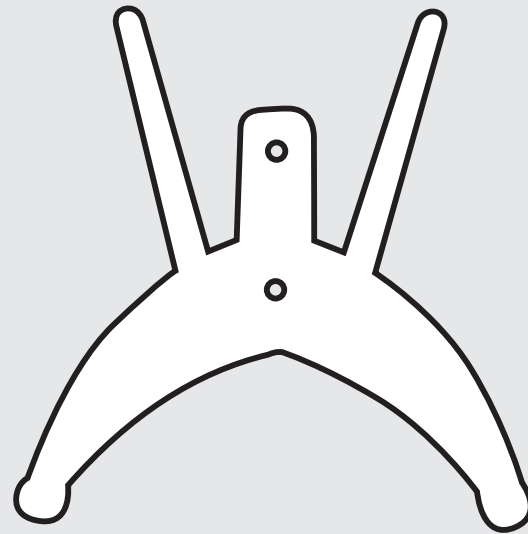

S202054

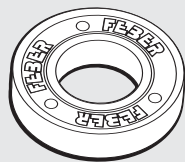
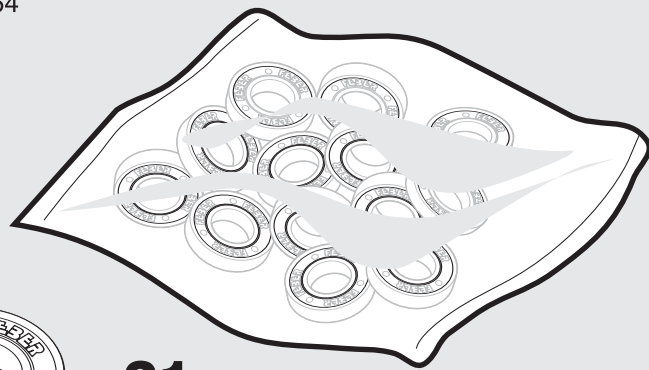

x21

amarillo • yellow • jaune • Gelb • Geel • o amarelo • giallo

S202053

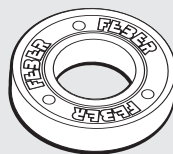
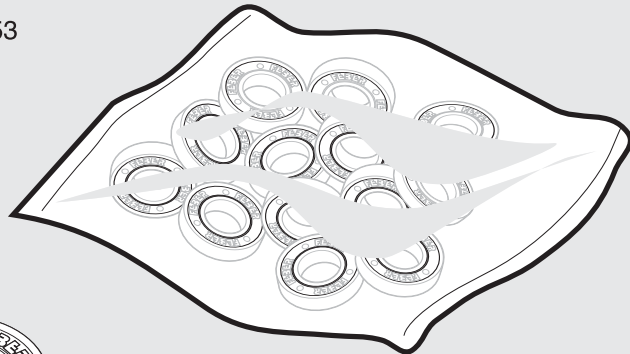

x21

rojo • red • rouge • rot • rood • vermelho • rosso

C S004751

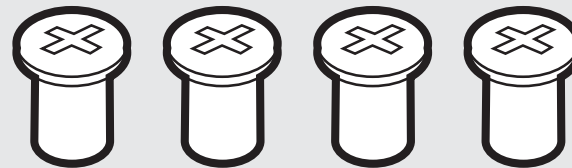

D S003430

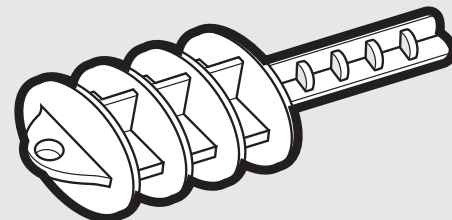

FEBER es una marca propiedad de:
 FEBER is a trademark of:
 FEBER est une marque déposée appartenant à:
 Die Marke FEBER ist Eigentum von:
 Het merk FEBER is eigendom van:
 A FEBER é uma marca propriedade da:
 FEBER è una marca proprietà di:
 FEBER er et registreret varemærke fra:
 FEBER är ett märke som tillhör:
 FEBER er et merke som tilhører:
 FEBER-tuotemerkin omistaa:
 "فبراير" علامة تجارية مسجلة "فبراير"



Fábricas Agrupadas de Muñecas de Onil S.A.
 C/ San Antonio nº8,
 03430 Onil (Alicante), España
 C.I.F.: A-84 392 596



SUPER 4 IN LINE



**MONTAJE • ASSEMBLY • ASSEMBLAGE • BEDIENUNGSANLEITUNG • MONTAGE
• MONTAGEM • MONTAGGIO • MONTERING • KOKOONPANO • التركيب**



• REALIZAR POR UN ADULTO
• THIS SHOULD BE DONE BY AN ADULT
• A RÉALISER PAR UN ADULTE
• DIES IST VON EINEM ERWACHSENEN AUSZUFÜHREN
• UIT TE VOEREN DOOR EEN VOLWASSENE

• A REALIZAR POR UM ADULTO
• DEVE REALIZARLO UN ADULTO
• يقوم بالعمل شخص بالغ

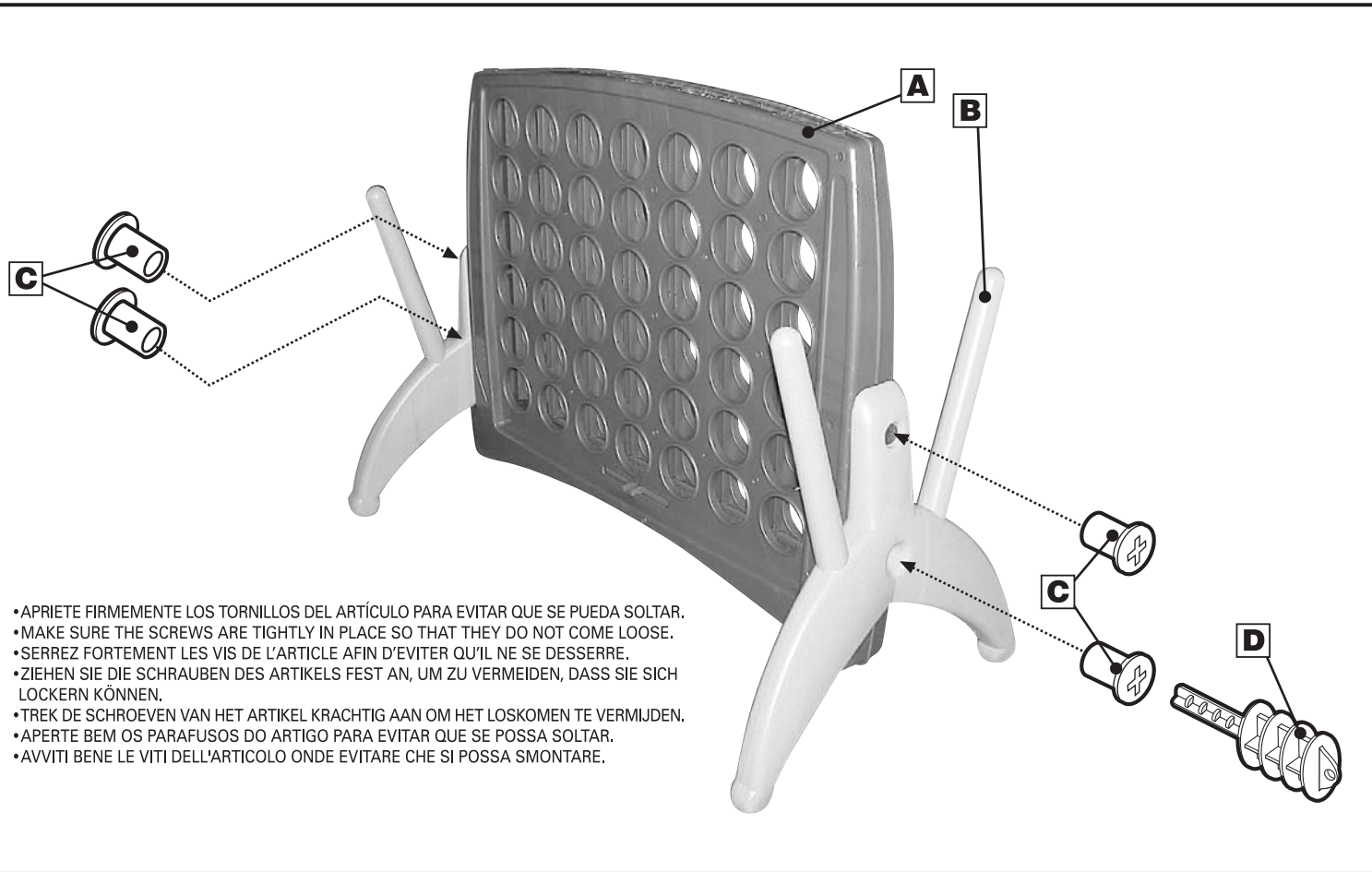

• APRIETE FIRMEMENTE LOS TORNILLOS DEL ARTÍCULO PARA EVITAR QUE SE PUEDA SOLTAR.
• MAKE SURE THE SCREWS ARE TIGHTLY IN PLACE SO THAT THEY DO NOT COME LOOSE.
• SERREZ FORTEMENT LES VIS DE L'ARTICLE AFIN D'ÉVITER QU'IL NE SE DESSERRE.
• ZIEHEN SIE DIE SCHRAUBEN DES ARTIKELS FEST AN, UM ZU VERMEIDEN, DASS SIE SICH LOCKERN KÖNNEN.
• TREK DE SCHROEVEN VAN HET ARTIKEL KRACHTIG AAN OM HET LOSKOMEN TE VERMIJDEN.
• APERTE BEM OS PARAFUSOS DO ARTIGO PARA EVITAR QUE SE POSSA SOLTAR.
• AVVITI BENE LE VITI DELL'ARTICOLO ONDE EVITARE CHE SI POSSA SMONTARE.

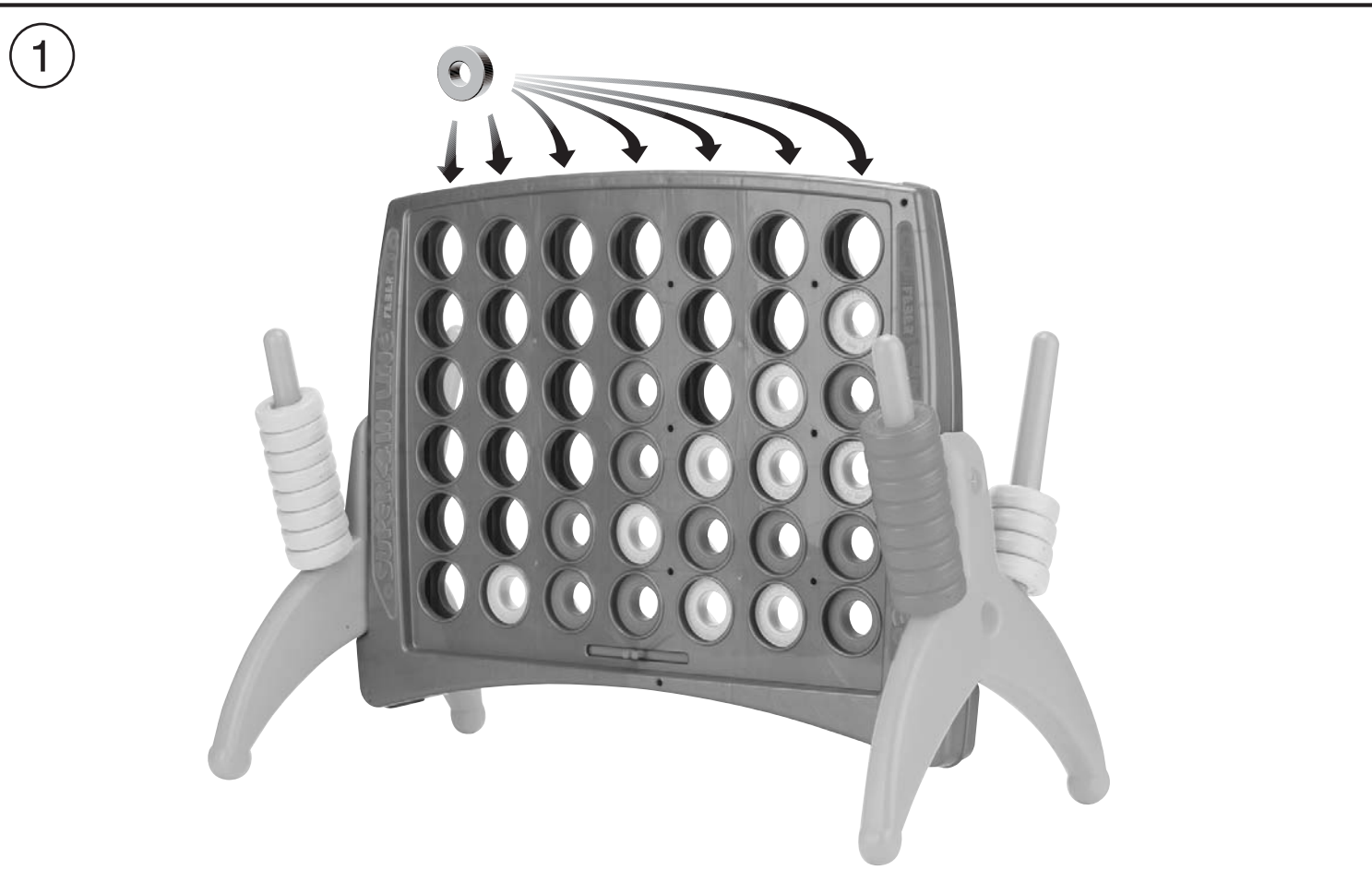

2

Combinaciones ganadoras de SUPER 4 IN LINE:
SUPER 4 IN LINE winning combinations:
Combinations gagnantes de SUPER 4 IN LINE:
Gewinner Kombinationen des SUPER 4 IN LINE
Winnende combinaties van het 'Vier Op Een Rij' Super-spel.
Combinações ganhadoras de SUPER 4 IN LINE.
Combinazioni vincenti di SUPER 4 IN LINE.

EJEMPLO
EXAMPLE
BEISPIEL
ESEMPIO

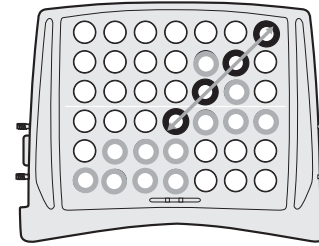

DIAGONAL
DIAGONALE
DIAGONAAL

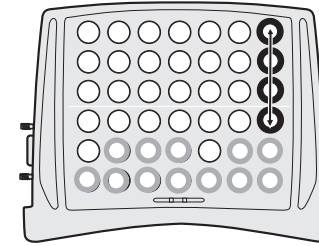

VERTICAL
VERTIKAL
VERTICALE
VERTICAAL

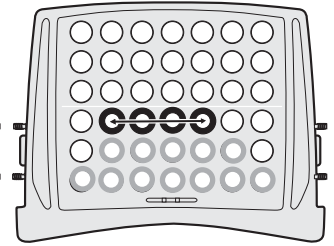

HORIZONTAL
WAAGERECHT
ORIZZONTALE
HORIZONTALAAL

3

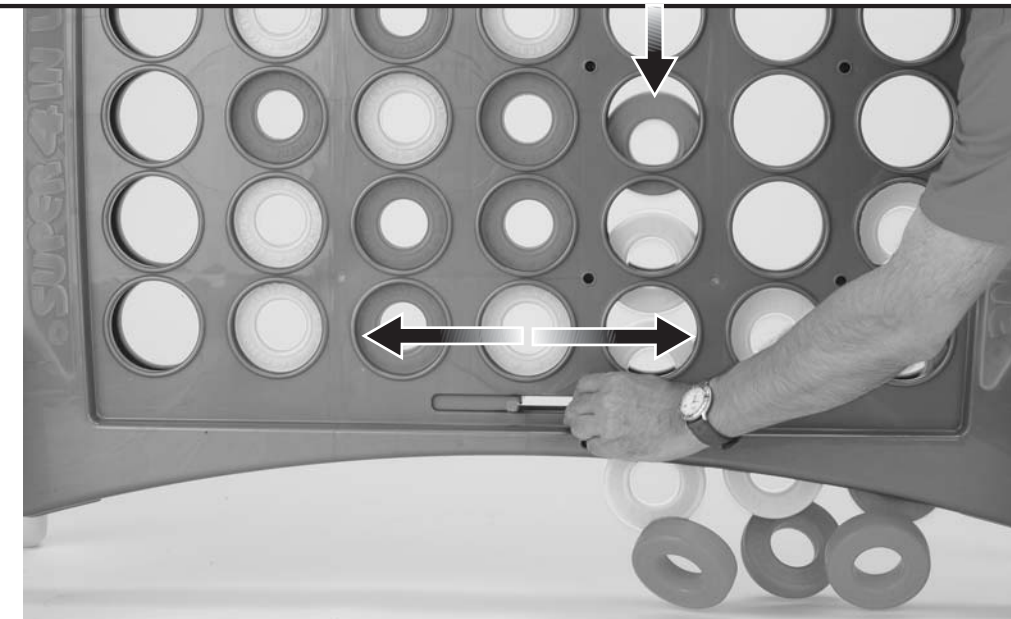

4

